

RUBBER EXPANSION JOINTS SINGLE SPHERE FLANGED END

GENERAL CHARACTERISTICS:

Range from ND32 up to ND600.
 Designed to absorb dilatation movements, vibrations in fluid conduction pipelines from any direction.
 Single wave construction with low load loss.
 Made with a special molding technique using synthetic fiber of high resistance, they can support a braking pressure of more than 60 bar, even if the usual working pressure is not above 16 bar.

APPLICATION:

Heating, air conditioning, cooling overheated water, water systems, pump stations, connection of compressors, industrial & ship installations.



STANDARDS:

Mounting with flanges: EN 1092-1 PN10 / PN16/ANSI150#
 Flange according to DIN2632
 Side flanges according to: ISO 7005-1.
 Pressure Test: EN 12266-1, class A.
 Body: 24 bars.

Products excluded from directive 2014/68/EU Equipment under pressure (Article 4 & 3).

WORKING CONDITIONS:

Maximum Working Pressure: 16 bar (*)
 Explosion Pressure: 50 bar.
 Working Temperature: - 10 °C - + 100 °C.
 See correction chart according to temperature.
 Vacuum KPa(mmHg) 65(490).

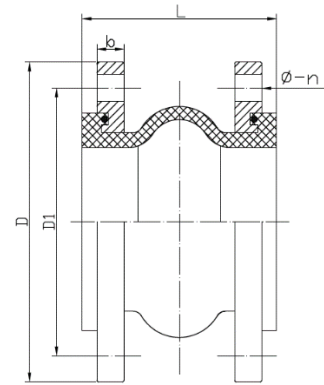

SINGLE WAVE DIMENSIONS

DN	L	Weight	PN 10				PN 16				DISPLACEMENT			Angle
			D	D1	b	φ-n	D	D1	b	φ-n	Extens.	Compr.	Transv.	
32	95	2.6	140	100	14	18-4	140	100	14	18-4	6	9	9	15°
40	95	3.1	150	110	14	18-4	150	110	14	18-4	6	10	9	15°
50	105	4.2	165	125	15	18-4	165	125	15	18-4	7	10	10	15°
65	115	5.2	185	145	15	18-4	185	145	15	18-4	7	13	11	15°
80	130	6.2	200	160	17	18-8	200	160	17	18-8	8	15	12	15°
100	135	7.5	220	180	17	18-8	220	180	17	18-8	10	19	13	15°
125	170	10.3	250	210	19	18-8	250	210	19	18-8	12	19	13	15°
150	180	12.8	285	240	19	22-8	285	240	19	22-8	12	20	14	15°
200	205	18.6	340	295	21	22-8	340	295	21	22-12	16	25	22	15°
250	240	27.2	395	350	23	22-12	405	355	23	26-12	16	25	22	15°
300	260	34.5	445	400	22	22-12	460	410	24	26-12	16	25	22	15°
350	255	45.6	505	460	22	22-16	520	470	26	26-16	16	25	22	15°
400	255	58.4	565	515	22	26-16	580	525	28	30-16	16	25	22	15°
450	255	68.0	615	565	22	26-20	640	585	28	30-20	16	25	22	15°
500	255	90.2	670	620	24	26-20	715	650	30	33-20	16	25	22	15°
600	260	122.5	780	725	23	30-20	840	770	31	36-20	16	25	22	15°



RUBBER EXPANSION JOINTS SINGLE SPHERE FLANGED END

NO.	PART	MATERIAL
1	BODY	EPDM/NBR
2	KEY FRAME	CORD FABRIC
3	PRESSURIZED RING	STEEL WIRE STRAND
4	FLANGED	STEEL Q235

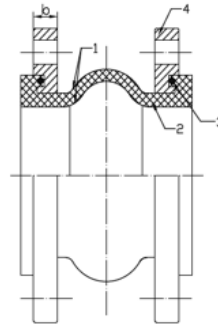

ELASTOMER

MATERIALS CODE	BODY	HIGHEST TEMPERATURE
BB	Butile	90°
EE	E.P.D.M.	105°
NY	Hypalon	100°
NN	Neoprene	90°
NBR	NBR	90°

TEMPERATURE / PRESSURE RATE FOR LONG LIFE (EPDM)

Ø NOMINAL	HIGHEST TEMPERATURE AND WORKING PRESSURE					
	80°C	85°C	90°C	95°C	100°C	105°C
32 a 300	15 BAR	12 BAR	10 BAR	7 BAR	4 BAR	2 BAR
350 a 600	10 BAR	8 BAR	7 BAR	5 BAR	2 BAR	1 BAR

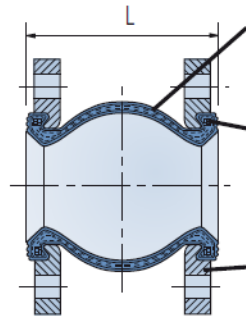

Body of synthetic rubber and reinforcing fiber.

Reinforcing ring make of steel for spring.

Cast C. Steel plated flanges.

WORKING PRESSURE/ TEMPERATURE TABLE

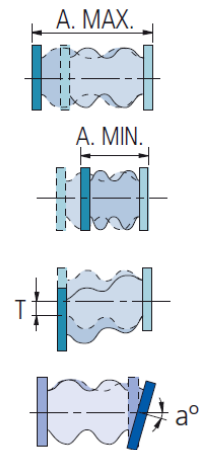
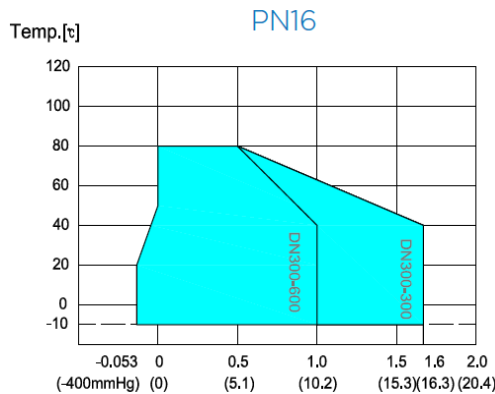
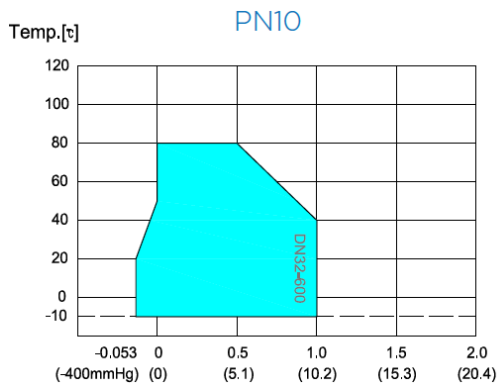

RUBBER EXPANSION JOINTS SINGLE SPHERE FLANGED END

ASSEMBLY POSITION

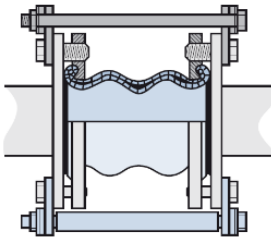

TIE RODS INCLUDE NUTS AND WASHES.

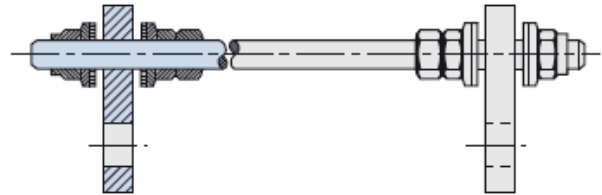

Nº TIE RODS RECOMMENDED

DN	BAR			
	5	7	10	15
40	-	-	-	•
50	-	-	-	•
65	-	-	-	•
80	-	-	-	•
100	-	-	•	•
125	-	-	•	•
150	-	-	•	•
200	-	•	•	•
250	-	•	-	-
300	-	•	-	-
350	-	•	-	-
400	•	-	-	-
450	•	-	-	-
500	•	-	-	-
600	•	-	-	-

ND	PN10	PN16
40		2
50		2
65		2
80		2
100		2
125		2
150		2
200	2	2
250	2	2
300	4	4
350	4	4
400	4	4
450	4	4
500	4	4
600	4	4

TIE RODS NECESSARY FOR CORRECT ASSEMBLY

